

---

# GoFlex Satellite™ User Guide



---

## GoFlex Satellite™ User Guide

© 2012 Seagate Technology LLC. All rights reserved. Seagate, Seagate Technology, the Wave logo, FreeAgent, GoFlex, GoFlex Satellite and GoFlex Media are trademarks or registered trademarks of Seagate Technology LLC, or one of its affiliates. iPod, iPad, iPhone, Time Machine, Safari and Mac are trademarks or registered trademarks of Apple Computer, Inc. and used to indicate compatibility. All other trademarks or registered trademarks are the property of their respective owners. When referring to hard drive capacity, one gigabyte, or GB, equals one billion bytes and one terabyte, or TB, equals one thousand billion bytes when referring to hard drive capacity. In addition, some of the listed capacity is used for formatting and other functions, and thus will not be available for data storage. Quantitative usage examples for various applications are for illustrative purposes. Actual quantities will vary based on various factors including file size, file format, features, and application software. Seagate reserves the right to change, without notice, product offerings or specifications.

Seagate Technology LLC  
10200 S. De Anza Blvd.  
Cupertino, CA 95014  
USA

---

## Regulatory Compliance

### FCC Class B Information

This equipment has been tested and found to comply with the limits for a Class B digital device, pursuant to Part 15 of the FCC Rules. These limits are designed to provide reasonable protection against harmful interference in a residential installation. This equipment generates, uses and can radiate radio frequency energy and, if not installed and used in accordance with the instructions, may cause harmful interference to radio communications. However, there is no guarantee that interference will not occur in a particular installation. If this equipment does cause harmful interference to radio or television reception, which can be determined by turning the equipment off and on, the user is encouraged to try to correct the interference by one of the following measures:

- Reorient or relocate the receiving antenna.
- Increase the separation between the equipment and receiver.
- Connect the equipment into an outlet on a circuit different from that to which the receiver is connected.
- Consult the dealer or an experienced radio/TV technician for help.

This device complies with Part 15 of the FCC Rules. Operation is subject to the following two conditions: (1) This device may not cause harmful interference, and (2) this device must accept any interference received, including interference that may cause undesired operation.

**FCC Caution:** Any changes or modifications not expressly approved by the party responsible for compliance could void the user's authority to operate this equipment.

### **IMPORTANT NOTE: FCC Radiation Exposure Statement**

This equipment complies with FCC radiation exposure limits set forth for an uncontrolled environment. This equipment should be installed and operated with minimum distance 20cm between the radiator & your body.

This transmitter must not be co-located or operating in conjunction with any other antenna or transmitter.

The availability of some specific channels and/or operational frequency bands are country dependent and are firmware programmed at the factory to match the intended destination. The firmware setting is not accessible by the end user.

Note to US model owner: To comply with US FCC regulation, the country selection function has been completely removed from all US models. The above function is for non-US models only.

---

## Industry Canada

This device complies with RSS-210 of the Industry Canada Rules. Operation is subject to the following two conditions: (1) This device may not cause harmful interference, and (2) this device must accept any interference received, including interference that may cause undesired operation.

Ce dispositif est conforme à la norme CNR-210 d'Industrie Canada applicable aux appareils radio exempts de licence. Son fonctionnement est sujet aux deux conditions suivantes: (1) le dispositif ne doit pas produire de brouillage préjudiciable, et (2) ce dispositif doit accepter tout brouillage reçu, y compris un brouillage susceptible de provoquer un fonctionnement indésirable.

**IMPORTANT NOTE:** (For mobile device use)

### **Radiation Exposure Statement:**

This equipment complies with IC radiation exposure limits set forth for an uncontrolled environment. This equipment should be installed and operated with minimum distance 20cm between the radiator & your body.

**NOTE IMPORTANTE:** (Pour l'utilisation de dispositifs mobiles)

### **Déclaration d'exposition aux radiations:**

Cet équipement est conforme aux limites d'exposition aux rayonnements IC établies pour un environnement non contrôlé. Cet équipement doit être installé et utilisé avec un minimum de 20 cm de distance entre la source de rayonnement et votre corps.

## Battery Safety

This product contains a lithium-ion battery that must be disposed of properly. See [www.seagate.com/support/goflexsatellite](http://www.seagate.com/support/goflexsatellite) for information about recycling and proper disposal.

Please follow the battery safety items below:

- Do not dismantle, open or shred secondary cells or batteries.
- Do not expose cells or batteries to heat or fire. Avoid storage in direct sunlight.
- Do not short-circuit a cell or a battery. Do not store cells or batteries haphazardly in a box or drawer where they may short-circuit each other or be short-circuited by, other metal objects.
- Do not use any charger other than that specifically provided for use with the equipment.
- Do not use any cell or battery which is not designed for use with the equipment.
- Do not mix cells of different manufacture, capacity, size or type within a device.
- Seek medical advice immediately if a cell or a battery has been swallowed.
- Do not subject cells or batteries to mechanical shock.

- 
- In the event of a cell leaking, do not allow the liquid to come in contact with the skin or eyes. If contact has been made, wash the affected area with copious amounts of water and seek medical advice.
  - Keep cells and batteries out of the reach of children.
  - Keep cells and batteries clean and dry.
  - Secondary cells and batteries need to be charged before use. Always use the correct charger and refer to the manufacturer's instructions or equipment manual for proper charging instructions.
  - Do not leave a battery on prolonged charge when not in use.
  - After extended periods of storage, it may be necessary to charge and discharge the cells or batteries several times to obtain maximum performance.
  - Secondary cells and batteries give their best performance when they are operated at normal room temperature (20°C+5 °C).
  - Retain the original product literature for future reference.
  - Use only the cell or battery in the application for which it was intended.
  - Dispose of properly.



---

# Contents

<b>1. Introduction</b>	<b>1</b>
About This Guide	1
GoFlex Satellite Features	1
Product Specifications	2
Supported Devices	2
Supported Web Browsers	2
Supported File Types	3
Hardware Specifications	3
About GoFlex Satellite™ Wi-Fi Security	4
<b>2. Setting up the GoFlex Satellite™ Device</b>	<b>5</b>
Unpacking Your Box	5
Step 1: Connecting Your GoFlex Satellite™ Device to Your Computer	6
Step 2: Setting up Your Device and Loading Content	6
Set up Your Device	6
Loading Content	6
Step 3: Disconnecting and Powering On	7
Step 4: Connecting to Your GoFlex Satellite Network	7
Connecting to the GoFlex Satellite Network from an Apple or Android Device	8
Connecting to the GoFlex Satellite Network From a Mac Computer Using AirPort®	8
Connecting to the GoFlex Satellite Network from a Smartphone	9
Connecting to the GoFlex Satellite Network from a Computer or Browser	9
<b>3. Enjoying Your Videos, Photos, and Music</b>	<b>10</b>
Installing GoFlex Satellite apps	10
Installing the GoFlex Media app	10
Installing Seagate Media Sync	10
Viewing and Playing Your Media	10
Searching for Files	11
Playing Videos	11
Viewing Photos	12
Playing Music	13
Viewing Documents	14

---

Viewing Content in Folders .....	14
Viewing Files on a Partitioned Drive .....	14
Rearranging Files in the app .....	14
Downloading Content to Your Media Device or Computer .....	15
Wirelessly Uploading Content From a Computer Your GoFlex Satellite Device .....	15
Synchronizing Your Files with Seagate Media Sync .....	15
Copying and Synchronizing Files Using a Mac Computer .....	16
Copying and Synchronizing Files Using a Windows Computer .....	16
Managing Your Connected Drives .....	18
Viewing Device Information .....	18
Changing the Seagate Advisor Setting .....	18
<b>4. Managing Your GoFlex Satellite™ Device .....</b>	<b>20</b>
Resetting Your GoFlex Satellite Device .....	20
Restarting Your GoFlex Satellite Device .....	20
Shutting Down the GoFlex Satellite Device .....	21
Restoring GoFlex Satellite to its Original Settings .....	21
Updating GoFlex Satellite Software .....	22
Changing the Name of Your GoFlex Satellite Device .....	22
Disconnecting From the GoFlex Satellite Network .....	22
Setting a Password .....	22
Changing the Language of the GoFlex Media™ app .....	23
Disconnecting Your GoFlex Satellite Device From Your Computer .....	23
Deleting Content from Your GoFlex Satellite Device .....	23
<b>5. An Overview of Your GoFlex Satellite Device .....</b>	<b>24</b>
Understanding the Components of Your GoFlex Satellite Device .....	24
Charging the Battery .....	26
<b>6. Troubleshooting .....</b>	<b>27</b>
Common Problems and Solutions .....	27
Finding More Help .....	29



# 1. Introduction

Your *GoFlex Satellite*<sup>™</sup> mobile wireless storage device is a portable hard drive that broadcasts a wireless signal. You can store your digital media on the device and then stream content to an iPad<sup>®</sup>, iPhone<sup>®</sup>, iPod<sup>®</sup> touch, Android<sup>™</sup> tablet or smartphone, or other Wi-Fi enabled tablet, smartphone or computer.

See "Product Specifications" for a list of compatible devices and web browsers.

## About This Guide

This guide introduces the features of the *GoFlex Satellite* device, describes how to set up your *GoFlex Satellite* device, how to fill up your device with your digital media, and how to use your *GoFlex Satellite* device to enjoy your videos, photos, and music.

For additional information about your *GoFlex Satellite* device, view the Getting Started video (located on your device). For more information about the latest firmware, videos, and tips and troubleshooting, go to the Seagate Customer Support site at [www.seagate.com/support/goflexsatellite](http://www.seagate.com/support/goflexsatellite).

## GoFlex Satellite Features

Here's a list of some of the things you can do with your *GoFlex Satellite* device:

- **Store your movies, songs, and photos.** The 500GB hard drive can store over 300 high-definition movies (1.5GB MP4 H.264), 125,000 songs, or 100,000 photos<sup>1</sup>.
- **Load your media quickly.** Your device comes with a USB 2.0 and USB 3.0 ports for fast transfers, and supports interfaces such as *FireWire*<sup>®</sup> 800 and *powered eSATA*. Just plug your device into your PC or Mac computer and drag and drop files.
- **Share content with more people.** Your *GoFlex Satellite* device serves as a mobile wireless network. All you need to do is select your *GoFlex Satellite* device as your wireless network from the device you want to use (your iPad, iPhone, Android device, etc.) and then access your media. Your *GoFlex Satellite* device can stream three or more Wi-Fi enabled devices at the same time, so more than one person can access your wireless media library at the same time.
- **Enjoy up to five hours of continuous play.** Your *GoFlex Satellite* device (when fully charged) provides up to five hours of continuous streaming.<sup>2</sup>

---

1. Quantitative usage examples for various applications are for illustrative purposes. Actual quantities will be based on various factors, including file size, file format, features, and application software.

2. Exact battery life subject to product model, normal usage condition and configurations.

**Note:** If you're viewing high-resolution video, you may experience less than five hours of streaming.

- **Do more.** While you're listening to music or viewing movies or photos on your iPad, iPhone, Android tablet or smartphone, you can also browse the Internet, from your home network or your favorite WiFi hotspot.

**Notes:**

- The ability to browse the Internet from a computer or a non-iOS/non-Android Wi-Fi device is not supported.
- We do not recommend streaming HD video from the Internet while connected to the *GoFlex Satellite* network.
- **Manage your digital media files.** The *GoFlex Media*™ app, developed specifically for Apple and Android devices, helps you enjoy your music, photos, and videos with features such as: playing music in the background while using other apps, adding movie bookmarks, and personalizing photo slideshows. For more information, see “Enjoying Your Videos, Photos, and Music” on page 10.
- **Synchronize your media files.** *Seagate Media Sync*™ software, a free application available from Seagate, automatically synchronizes all of your media files with your *GoFlex Satellite* device. For more information, see “Synchronizing Your Files with Seagate Media Sync” on page 20.

## Product Specifications

The following lists identify the devices, browsers, file types, and hardware specifications for your *GoFlex Satellite* device.

### Supported Devices

Your *GoFlex Satellite* device can be used with these devices:

- iPad, iPhone, iPod touch running iOS 4 and above
- Android-based tablets and smartphones running Android release 2.1 and above
- Other Wi-Fi-enabled tablets and smartphones
- Windows® computer running Windows 7, Windows Vista® or Windows XP
- Mac® computer running Mac OS® X 10.5.8 or later operating systems

### Supported Web Browsers

You can use these browsers to access your media library on your *GoFlex Satellite* device:

- Safari® 5 or later (Mac OS)
- WebKit (Android)

- Internet Explorer® 8 or later (Windows)
- Firefox®
- Google Chrome™

## Supported File Types

### For iPads

- Video: H.264 video, MPEG-4, Motion-JPEG
- Audio: AAC, MP3, M4a, Audible (formats 2, 3, 4), Apple Lossless, AIFF, WAV
- Documents: Microsoft® Office®, iWork®, Adobe® Acrobat® (PDF)
- Select files supported by third-party apps

### For Laptops, Tablets, and Smartphones

- Any files supported by your device applications

## Hardware Specifications

- Drive Capacity: 500GB
- SuperSpeed USB 3.0 port (required for USB 3.0 transfer speeds) or USB 2.0 port
- Battery: Non-user replaceable lithium-ion battery
- Battery Life: Up to 5 hours of continuous streaming (1 user); up to 25 hours standby
- Maximum Wi-Fi range: 45 meters (147 feet)
- Drive Format: NTFS

The Paragon NTFS driver is available to enable read/write access using Mac operating system. The software is available on your *GoFlex Satellite* device.

## About GoFlex Satellite™ Wi-Fi Security

Since your *GoFlex Satellite* device is a *wireless* broadcasting device, it can be “seen” by any Wi-Fi device within its range (up to 45 meters/147 feet).

You can set a password to restrict access to your *GoFlex Satellite* device. See “Setting a Password” on page 28 to restrict access to your *GoFlex Satellite* device.

**Tip:** Remember that when you have your *GoFlex Satellite* device physically connected to your computer, wireless is disabled; your files are not visible to others.

## 2. Setting up the GoFlex Satellite™ Device

This chapter explains each step of the installation process in more detail than what is shown in the *Quick Start Guide*.

### Unpacking Your Box

Before you begin to set up your device, unpack the box and ensure you have all of these items before continuing:

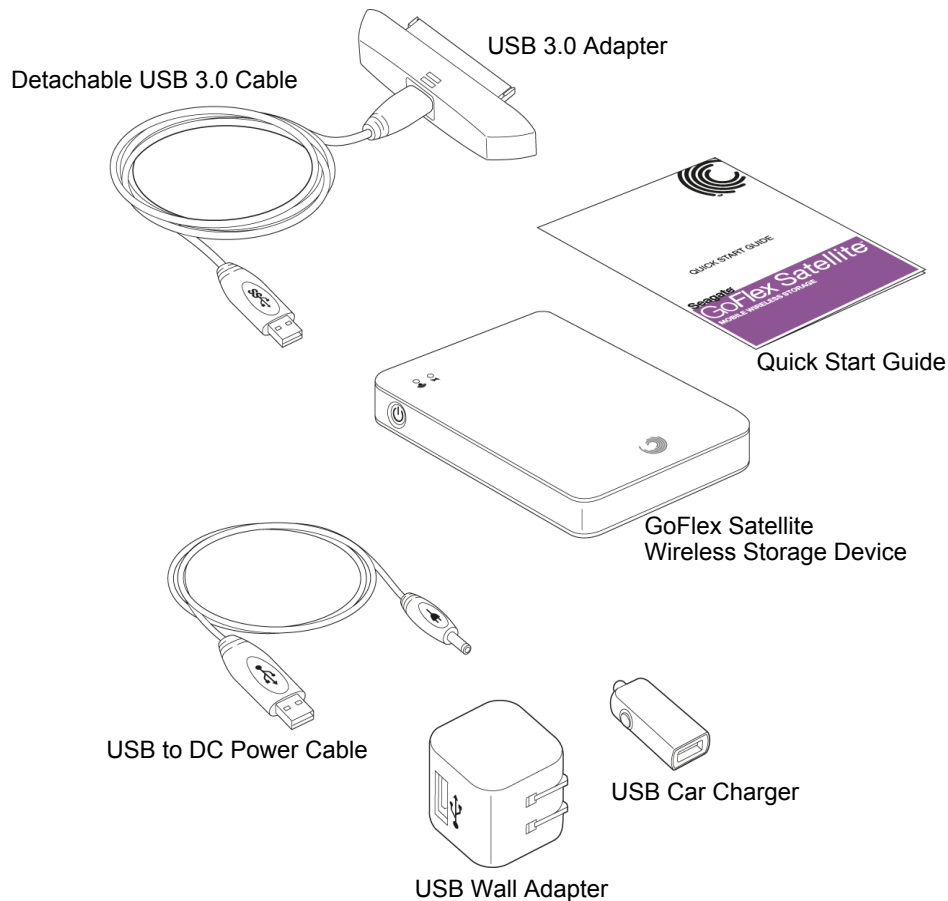

**Figure 1:** Package Contents

For a detailed description of these components, review “An Overview of Your GoFlex Satellite Device” on page 30.

## Step 1: Connecting Your GoFlex Satellite™ Device to Your Computer

The *GoFlex Satellite* device comes with a USB 3.0 adapter and cable. This USB 3.0 system provides faster transfer speeds when connected to a USB 3.0 port on your computer.

**Note:** If your computer does not have a USB 3.0 port, you can connect the cable to a USB 2.0 port.

1. Remove the plastic cover from the end of the *GoFlex Satellite* device to expose the connector.
2. Connect the USB 3.0 adapter and USB 3.0 cable to the *GoFlex Satellite* device, then connect to a USB port (2.0 or 3.0) on your computer.

## Step 2: Setting up Your Device and Loading Content

### Set up Your Device

Before you begin to fill up your *GoFlex Satellite* device with your media, please go to [seagate.com/support/goflexsatellite](http://seagate.com/support/goflexsatellite) and verify that you have the latest firmware.

Review the following table to ensure that no further setup is needed before you start copying files to your *GoFlex Satellite* device.

**Table 1:** Set up Requirements

Computer Type	Set up requirements
PC	No set up required.
Mac <sup>a</sup>	Install <b>MacInstaller.dmg</b> (located on your <i>GoFlex Satellite</i> device) to allow file copying.
PC and Mac	Install <b>MacInstaller.dmg</b> to format your <i>GoFlex Satellite</i> device to use with both PCs and Macs.

a. Do not allow Time Machine<sup>®</sup> to use your *GoFlex Satellite* device for backup. Time Machine will attempt to reformat the drive inside your *GoFlex Satellite* device. See “Troubleshooting” on page 33 if you reformat the drive by mistake.

### Loading Content

Once you’re physically connected to your *GoFlex Satellite* device, the easiest way to fill up your device is to drag and drop files from your computer to your device.

**Note:** It is the user's responsibility to comply with applicable copyright laws and to respect owner's rights in content usage.

You can also install *Seagate Media Sync*™ software to help you copy your files and synchronize them once they are on your *GoFlex Satellite* device. Review “Synchronizing Your Files with Seagate Media Sync” on page 20 for more information on how to install and use *Seagate Media Sync*.

---

**Note:** Your Apple® device, Android® device or other WiFi device will play files only in the formats it supports. See your device’s specifications for details.

---

## Step 3: Disconnecting and Powering On

Disconnect the USB 3.0 adapter and USB 3.0 cable from your *GoFlex Satellite* device, replace the plastic casing, and power on the device by pressing the power button.

---

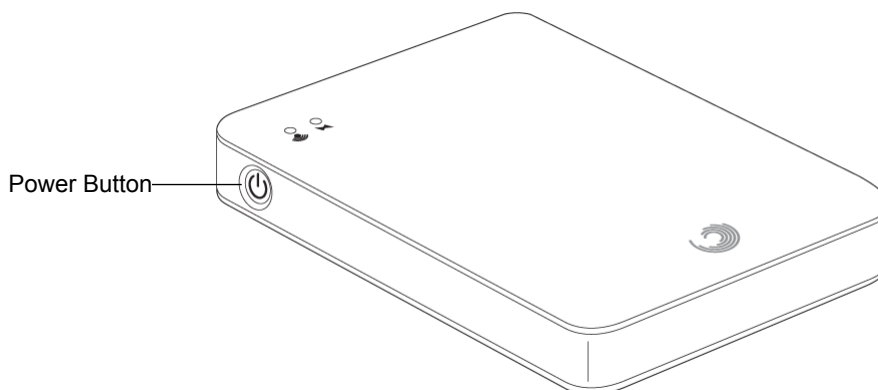

**Figure 2:** Powering on

Your Wi-Fi LED blinks green as your *GoFlex Satellite* device starts up. When the light is a solid green, your device is WiFi ready, indicating you can connect it to the *GoFlex Satellite* network.

**Tip:** Your *GoFlex Satellite* device is pre-charged from the factory and can run for approximately 45 minutes to 1 hour. You may want to charge your device before you connect to the *GoFlex Satellite* network and enjoy your videos, photos, and music. For more information on charging, see “Charging the Battery” on page 32.

For more information about all of the components (LED lights, cables, etc.) of your *GoFlex Satellite* device, review “An Overview of Your GoFlex Satellite Device” on page 30.

## Step 4: Connecting to Your GoFlex Satellite Network

Your *GoFlex Satellite* device has its own wireless network. When you connect to it, it establishes a dedicated link with *GoFlex Satellite* over Wi-Fi.

You can also connect to the Internet while connected to the *GoFlex Satellite* network. For example, you can connect from your favorite hotspot while watching a movie or listening to your favorite music on your device.

**Tip:** We do not recommend streaming a movie from the internet while connected to the *GoFlex Satellite* network.

Select one of these options to help you connect your device to the *GoFlex Satellite* network:

- *Connecting to the GoFlex Satellite Network from an Apple or Android Device*
- *Connecting to the GoFlex Satellite Network From a Mac Computer Using AirPort®*
- *Connecting to the GoFlex Satellite Network from a Smartphone*
- *Connecting to the GoFlex Satellite Network from a Computer or Browser*

## Connecting to the GoFlex Satellite Network from an Apple or Android Device

Apple and Android devices can use the *GoFlex Media* app to help you search for and play media files on your *GoFlex Satellite* device. We recommend that you install this app before you connect to the *GoFlex Satellite* network. For more information on how to install this app, see “Installing the GoFlex Media app” on page 10.

1. Open your wireless network settings:
  - For Apple devices, choose **Settings > Wi-Fi**.
  - For Android devices, choose **Settings > Wireless & network > Wi-Fi Settings**.
2. Select **GoFlex Satellite**.
3. Wait for the wireless network list to update and then select **GoFlex Satellite** from the list of networks.
4. Press the Home button on your Apple or Android device.



5. Tap the **GoFlex Media** app to open the application.

## Connecting to the GoFlex Satellite Network From a Mac Computer Using AirPort®

If there is an AirPort card installed in your Mac computer, you can connect to the GoFlex Satellite network. See the user documentation for your computer for the most up-to-date instructions on connecting to a wireless network.



1. Select **Apple > System Preferences**.
2. Under Internet and Network, select **Network**.
3. Select **AirPort** from the list of network connection services.
4. Select **GoFlex Satellite** from the list of networks.
5. Open Safari and then type “www.goflexsatellite” in the address bar.

The GoFlex Satellite main page displays.

## Connecting to the GoFlex Satellite Network from a Smartphone

You can connect to the *GoFlex Satellite* device from any Wi-Fi-enabled smartphone that has a browser. While connecting to a wireless device is similar on most smartphones, see the documentation that came with your phone for detailed instructions.

1. Go to your phone’s Wi-Fi settings.
2. Select **GoFlex Satellite** from the list of wireless networks.
3. Launch your phone’s Web browser.
4. Go to any URL to be automatically redirected to the GoFlex Satellite main page.

## Connecting to the GoFlex Satellite Network from a Computer or Browser

You can stream your content from *GoFlex Satellite* with a Web browser.

1. Enable the wireless connection on the device to which you want to stream from.
2. Select “GoFlex Satellite” from your device’s list of wireless networks.

After launching your device’s Web browser, go to any URL to be automatically redirected to the GoFlex Satellite main page, or type **www.goflexsatellite.com**.

## 3. Enjoying Your Videos, Photos, and Music

Seagate provides two free software applications that can help you enjoy and manage your digital media library:

- *GoFlex Media*™ app. This application (specifically for Apple and Android devices) categorizes the digital media files you copy to your *GoFlex Satellite* device.
- *Seagate Media Sync*™. This application synchronizes your media files and documents on your computer with your *GoFlex Satellite* device.

You can also enjoy your videos, photos, and music from a web browser.

If you've already installed these apps, skip to *Viewing and Playing Your Media*.

### Installing GoFlex Satellite apps

#### Installing the GoFlex Media app

1. Open the App store or Android Market from your device.

**Tip:** You can also download the app from the iTunes®.

2. Search for and install the *GoFlex Media* app.

Now you're ready to begin viewing and playing your media.

#### Installing Seagate Media Sync

1. Go to [www.seagate.com/support/goflexsatellite](http://www.seagate.com/support/goflexsatellite).
2. In the left navigation panel, click **Downloads**.
3. Click Seagate External Drives, then click GoFlex Satellite.
4. Locate the **Media Sync** software for your operating system and then download and install the software to your computer.

For more information on how to synchronize your files, see "Synchronizing Your Files with Seagate Media Sync" on page 20.

### Viewing and Playing Your Media

This section provides instructions for playing videos, listening to music, and viewing photos and documents using the *GoFlex Media* app or from a Web browser.

---

**Note:** Some features are accessed and perform differently in a Web browser. Sections that describe browser-only functionality are clearly marked.

---

## Searching for Files

If you have a lot of files stored on your *GoFlex Satellite* device, you can use the search tool (located at the top of all views) to find a specific file.

### To search for a file using the *GoFlex Media* app

1. Tap **Videos**, **Photos**, **Music**, **Documents** or **Folder View**.
2. Select the search tool at the top of the screen.



3. When the keyboard displays, type all or part of a file name and then press the **Search** key on the keyboard.

### To search for a file from a browser

1. Click in the search field at the top of the screen.
2. Using your keyboard, type all or part of a file name and then press **Return**.

The file you searched for is displayed on screen and ready to play.

## Playing Videos

Follow these steps to play videos that you have copied to your *GoFlex Satellite* device.

1. Open the *GoFlex Media* app or a Web browser.

## 2. Select the **Videos** view..

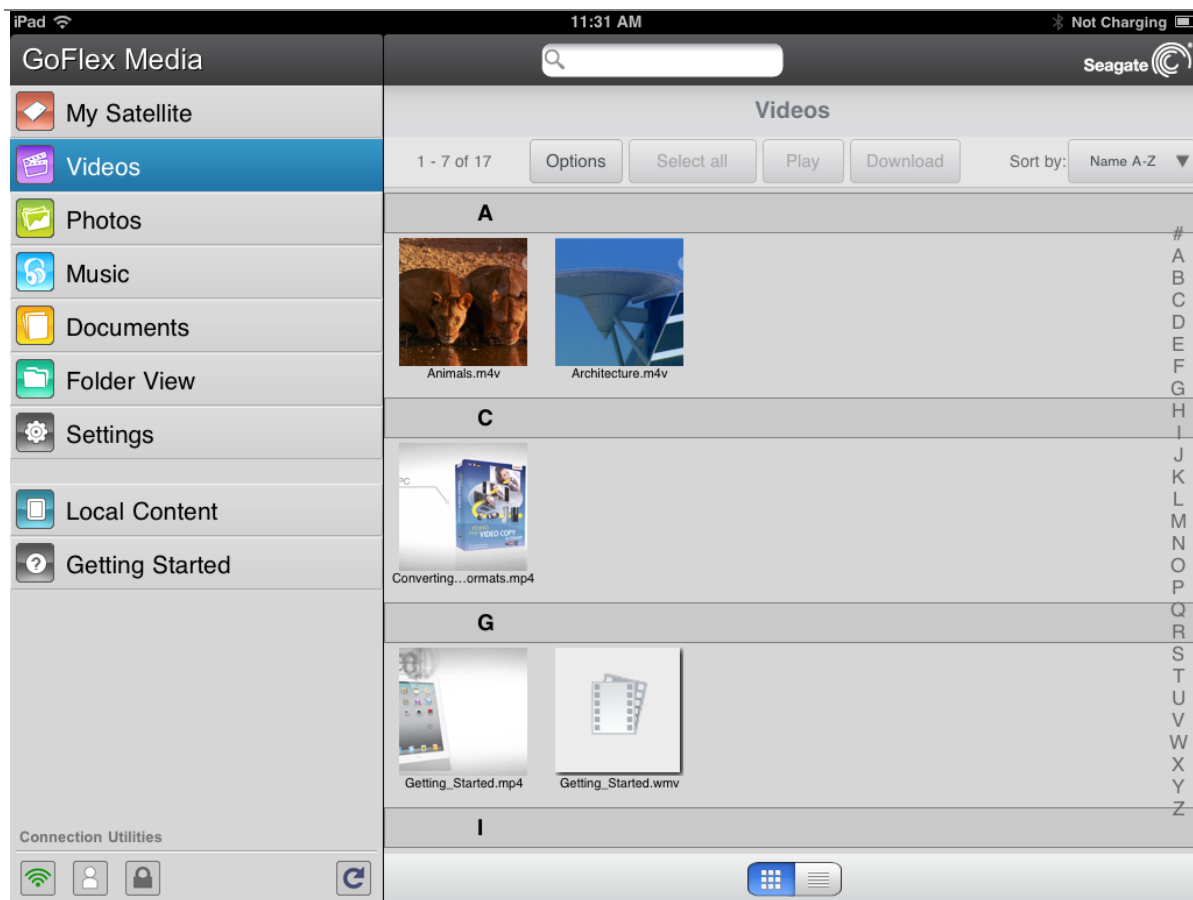

**Figure 3:** Videos Screen

## 3. Play your movie or video.

### To play a video

- Choose one of the following:
  - Select the video to start playback.
  - Select the **Options** button, select the video, and then select the **Play** button.

**Browser only:** You may need to select a media player to play the video. Depending on the size of the video you choose to play, some browsers download the entire video before the video can be played. A full length movie may take several minutes to load.

Your device's media player may be limited to playing only certain video formats. If a video that you copied to your *GoFlex Satellite* device does not play, it may be in a format not supported by your media player.

### To pause a video

- Using the app: Tap the screen and then tap the pause icon.

- From a browser: Click the pause button available in your media player.

**Tip:** When you pause a movie, the app automatically puts a bookmark in your movie. When you return to the movie, you will automatically resume watching your movie from where you paused it.

### To stop playback of a video

- Using the app: Tap the screen and then select the **Done** button in the upper left corner.
- From a browser: Close the media player.

To play all movies or videos, select the **Options** button > **Select all** button > **Play** button.

## Viewing Photos

1. Select the **Photos** view.



**Figure 4:** Photos Screen

2. To view photo(s)

- To view one photo, select the photo.  
**Tip:** You can zoom in on your photo thumbnails.

- To view multiple photos, tap the **Options** button, select the photos you want to view and then select the **Play** button. Your photos play back as a slideshow. Swipe forwards or backwards to show the next or previous photo in the slideshow.
- To view all photos, tap the **Options** button > **Select all** button > **Play** button.

#### **To view a slideshow**

- To start a slideshow, tap the Slideshow button when viewing a photo. You can add transition, time, loop, and shuffle effects.
- To pause a slideshow, tap the screen and then tap the pause icon.
- To accompany a slideshow with music, start playing music as described in “Playing Music” on page 15, select the photos you want to include in the slideshow, and then tap the **Play** button.
- To change the music that’s playing during the slideshow, tap the screen > **Now Playing** button > **Now Playing Details**, and tap the forward or back buttons.

#### **To stop playback of a slideshow**

- Using the app: Tap the screen and then tap the **Done** button in the upper left corner.
- From a browser: Close the current picture or click the back arrow or Home button.

## Playing Music

### 1. Select the **Music** view To play song(s)

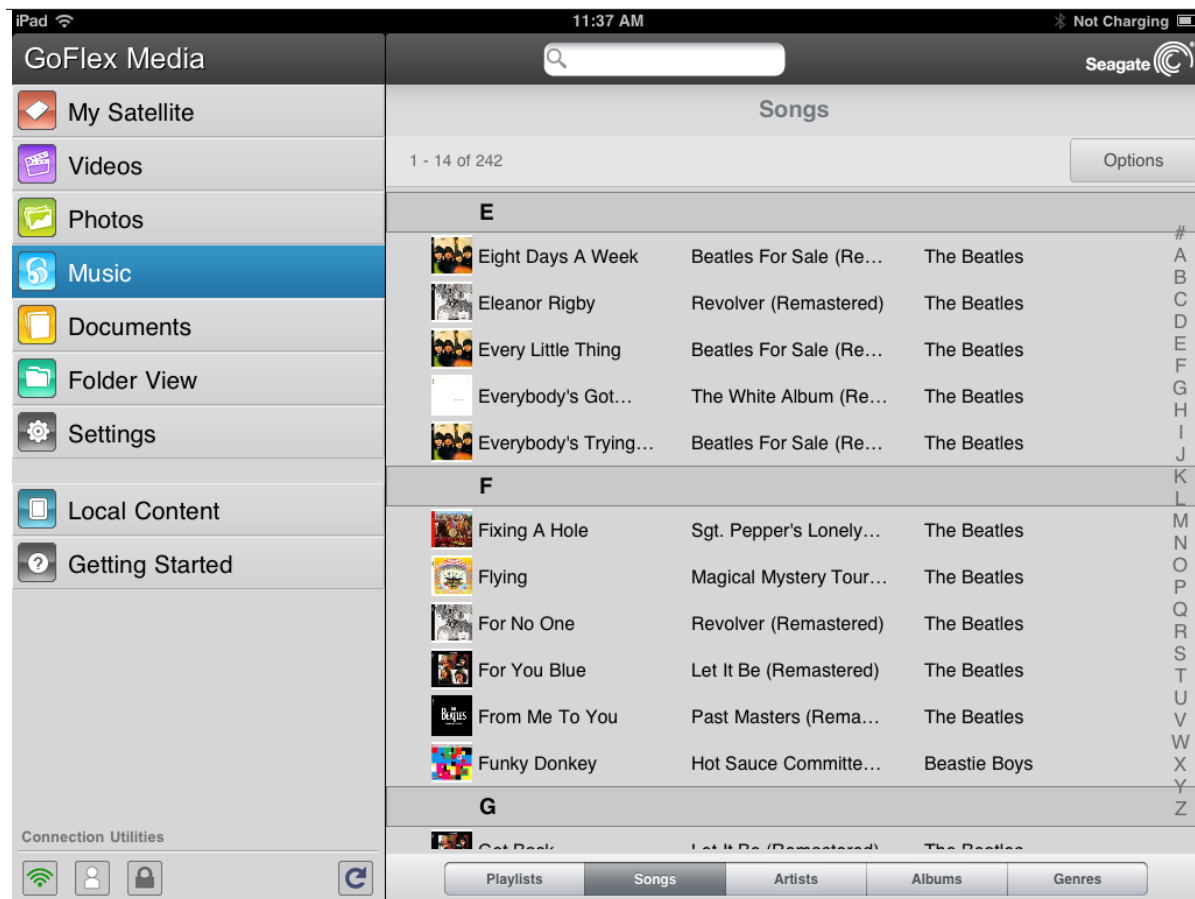

**Figure 5:** Music View

- To play one song, select the music file.
- To play multiple songs, tap the **Options** button, select the songs you want to play and then select the **Play** button.
- To play all songs, tap the **Options** button > **Select all** button > **Play** button.
- To play the contents of a playlist, tap the **Playlists** button and select a playlist.
- To display just the songs whose titles start with a specific letter, tap the **Songs** button, then tap the letter in the column on the right-hand side of the screen.
- To display the artists whose names start with a specific letter, tap the **Artists** button, then tap the letter in the column on the right-hand side of the screen.
- To display titles and artwork of all of the albums on your *GoFlex Satellite* device, tap the **Albums** button. Tap the album to list the songs in the album.

- To display songs that belong to a particular genre of music, tap the **Genres** button, then tap one of the music genres in the list.
- To skip or repeat songs, fast forward or rewind by sliding your finger across the Playback status bar.
- To locate a specific playlist, song, artist, album, or genre, select the appropriate button at the bottom of the screen, tap the Search box, and then type all or part of the name of what you are looking for.

For example, to find a specific song, tap the **Songs** button, then type all or part of the song title in the Search box.

- To play music in the background, close the *GoFlex Media* app and use other apps on your device. Your music continues to play.

### To control the currently playing song:



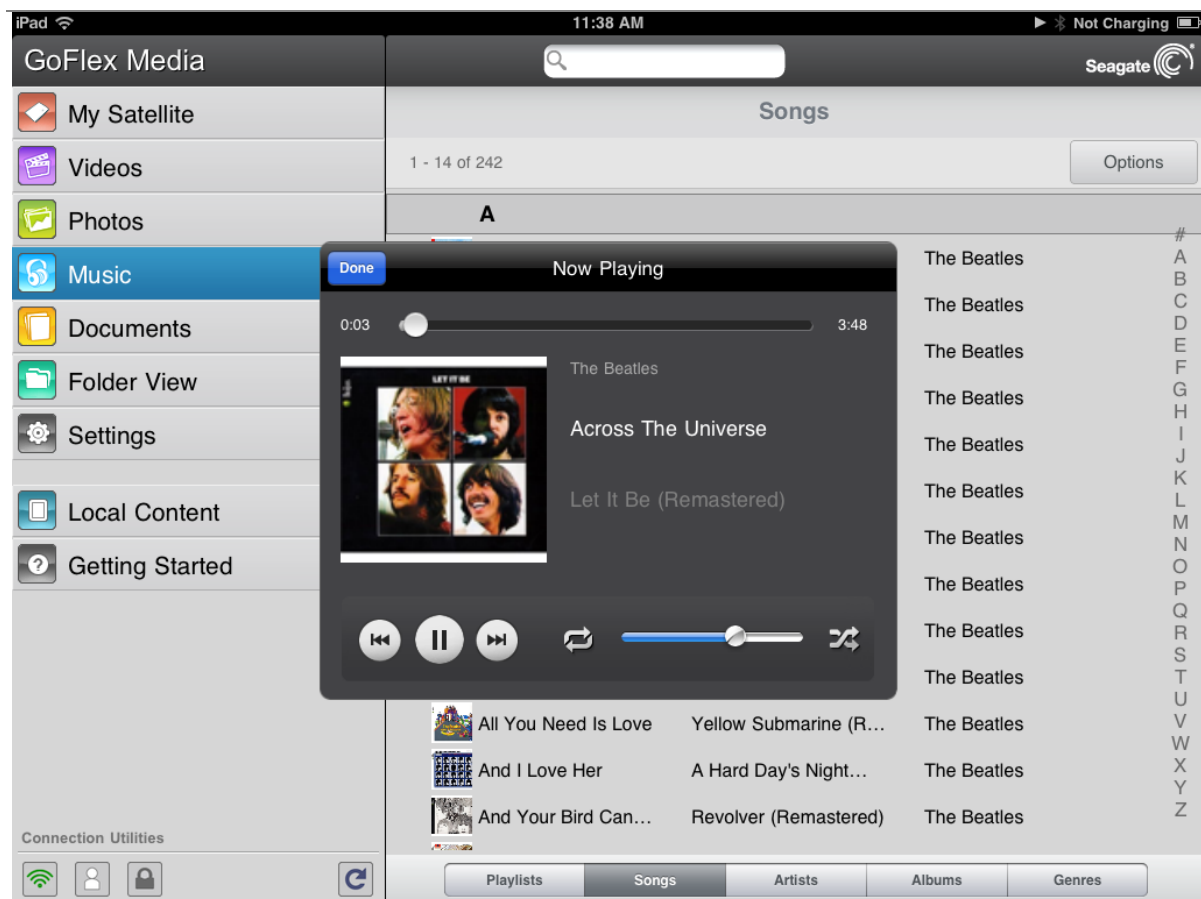

Tap the **Now Playing** button to display controls for the currently playing song.



**Figure 6:** Now Playing Screen

To pause the currently playing song, tap the  button.



- To skip to the next song in the selection, tap the  button.
- To go back to the previous song in the selection, tap the  button.
- To move forwards or backwards within the currently playing song, drag the bar at the top of the Now Playing screen.
- To repeat the currently playing song continuously, tap the  button.
- To play the songs in the selection in random order, tap the  button.
- To adjust the volume, drag the volume slider at the bottom of the Now Playing screen.

## Viewing Documents

1. Select the **Documents** view.

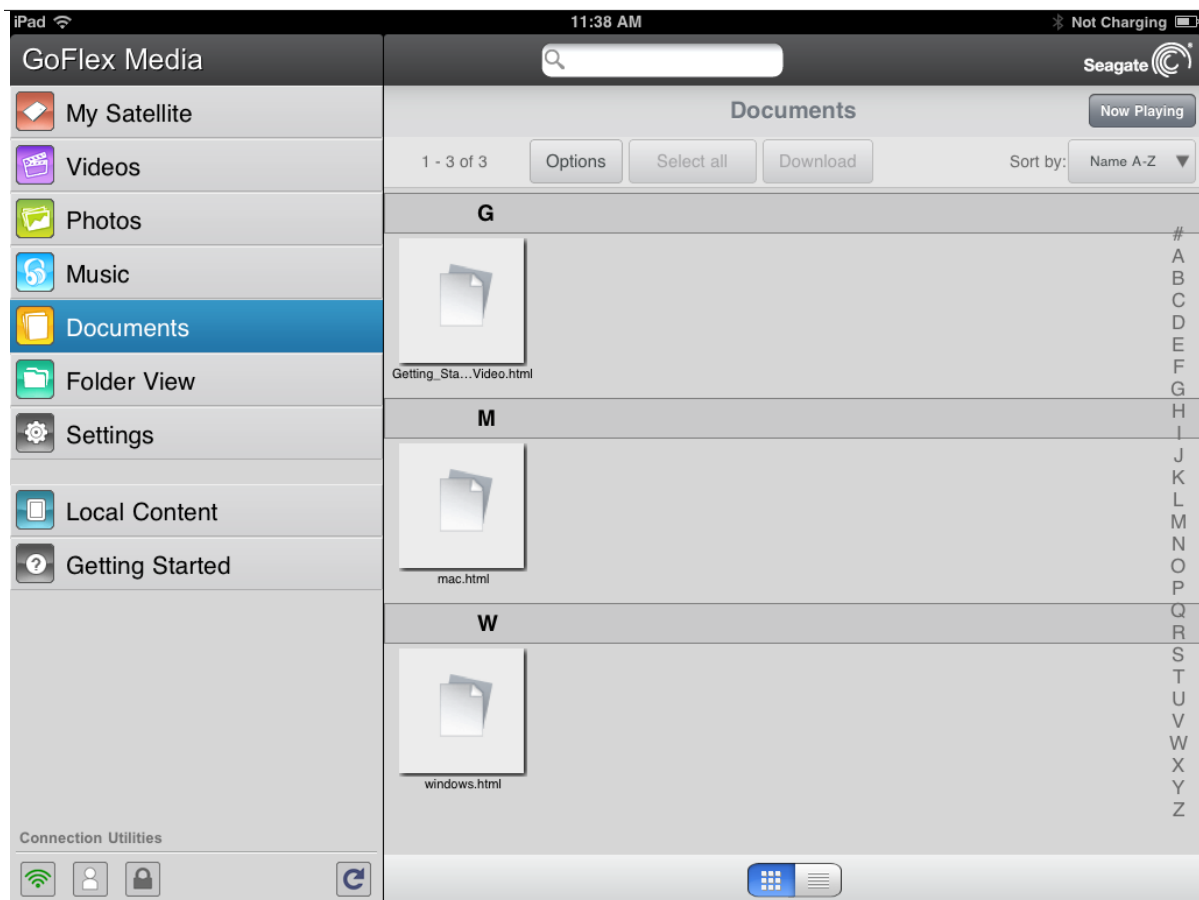

**Figure 7:** Documents Screen

2. Tap (app) or click (browser) the document you want to view.

Not all documents can be viewed on all devices. See your device's documentation for a list of supported document types.

## Viewing Content in Folders

This feature is available in the *GoFlex Media* app only.

The **Folder View** provides another way to view your content stored on your *GoFlex Satellite* device, showing your files and folders in their original structure from your computer. If you prefer to access your files from this view, the same playback controls are available to you.

1. Tap the **Folder View** on the *GoFlex Media* Home screen.

As you navigate the folders, the current folder you are viewing and the folder from which you started are shown above the top menu buttons. Click the left arrow to navigate back to the top level.

## Viewing Files on a Partitioned Drive

If you have created additional partitions on your *GoFlex Satellite* drive, a menu is available to choose among the partitions. This menu only appears if there is more than one partition on the drive.

To select a partition:

1. Select the **My Satellite**.
2. On the top menu, select **Select Partition** and then choose the partition that contains the content you want to view.

Only the content from the partition you choose is shown. Select a different partition from the menu to refresh the My Satellite screen and view the content for the selected partition.

## Rearranging Files in the app

You can rearrange the files currently shown on-screen into a different order by selecting one of the following options from the **Sort by** menu: Name A-Z, Name Z-A, Date Ascending, Date Descending and File Type.



**Figure 8:** Sort by Menu

To rearrange the files, select the button next to **Sort by** and then choose a different order.

## Downloading Content to Your Media Device or Computer

In addition to streaming your content from the *GoFlex Satellite* device, you can copy files from the *GoFlex Satellite* device to your media device or computer. Your only limit to the number of files you can download is the available storage space on your media device or computer.

To download files:

1. Locate the file(s) that you want to download in one of the media views (Videos, Photos, Music, Documents).
2. Select the **Options** button and then either individually select the files to download or select **Select all** to choose all of the files in the current view.

**3. Select the **Download** button.**

The files begin to download to your device. To stop downloading of a file, select the X on the icon of a downloading file.

The files you download to your device are available for playback from the Local Content section of the *GoFlex Media* app. If you are using a computer, downloaded files are stored in the location you chose.

## Wirelessly Uploading Content From a Computer Your *GoFlex Satellite* Device

If you have files on your computer that you want to upload to the *GoFlex Satellite* device without the device being physically connected to your computer, you can do so from your computer's Web browser.

1. Connect to the *GoFlex Satellite* network from your computer. (See "Connecting to the GoFlex Satellite Network from a Computer or Browser" on page 9.)
2. From the *GoFlex Satellite* main screen, navigate to one of the media views: Videos, Photos, Music, Documents.
3. Click the **Upload** button on the top menu.
4. Enter the file name or click **Browse** and then locate the file you want to copy to your *GoFlex Satellite* device.
5. Click **Upload**.

The file is added to its pre-defined category.

## Synchronizing Your Files with Seagate Media Sync

If you haven't installed the Seagate Media Sync software, review "Installing Seagate Media Sync" on page 10.

### Copying and Synchronizing Files Using a Mac Computer

1. Connect the USB 3.0 adapter and cable to the *GoFlex Satellite* device and to your computer.

Make sure that the device appears in the left panel of the *Seagate Media Sync* window. If more than one device is connected to your computer, select the appropriate device for synchronization. Each device has its own settings.

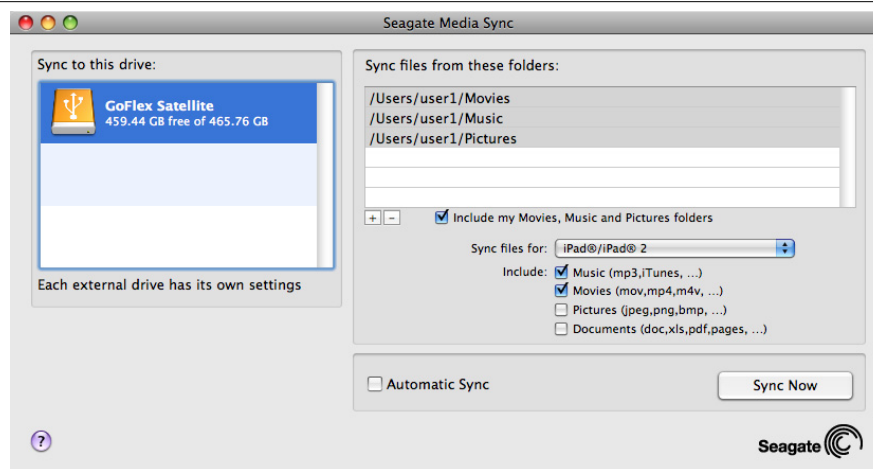

**Figure 9:** Seagate Media Sync for Mac

2. In the right panel of the application window, select **Include my Movies, Music and Pictures folders** to use your Mac's default media folders as the source folders. These are the folders that were automatically created when the user account was set up on your Mac. (Click inside the box if you want to remove the folders from the list.)
3. To include other files and folders from your computer, click the **+** button and then navigate to the source media folder(s). (Click the **-** button to remove an item from the list.) When the new window appears, select the files and folders to sync and then click **Add to Sync**. Repeat for all files and folders you wish to include.
4. To sync only the files that can be opened on specific Apple devices, click the menu next to **Sync files for** on the bottom right section and then choose the device(s) from the list. Or, keep the menu set to **all digital devices** to sync all files that are identified as movies, music or images with any device.
5. Below **Sync files for**, select one or more of the boxes to filter what is synchronized. For example, select Music and Movies and then leave Pictures and Documents unchecked if you want to sync only your movies and music files. Rest your mouse on a box (Music, Movies, Pictures, Documents) to see the included file types.
6. Click **Sync Now**. The synchronization process is complete when the spinning activity indicator stops. To cancel the synchronization process, click **Stop Sync**. The process stops once the current file finishes synchronizing.

## Using Automatic Sync

The Automatic Sync feature continuously tracks file changes in synchronized folders and automatically synchronizes revised versions by overwriting older versions with newer versions. Automatic Sync can occur only when your external drive is connected.

Automatic Sync is turned off by default. If you want your drive synchronized automatically while it's connected, you can turn on the Automatic Sync feature.

## Copying and Synchronizing Files Using a Windows Computer

1. Connect the USB 3.0 adapter and cable to the *GoFlex Satellite* device and to your computer.
2. Start *Seagate Media Sync*. Make sure that the *GoFlex Satellite* drive appears in the My Drives window.
3. Click the **Media Sync** icon in the menu bar.

There are three different methods available to copy your files to the *GoFlex Satellite* device, described below. Choose the method best suited for your needs.



**Figure 10:** Seagate Media Sync for Windows

### Simple iPad Sync

Click **Simple iPad Sync** to automatically synchronize only the media files that an iPad can play or view. Click **OK** on the confirmation screen to complete the sync task. If you want to make changes to the plan after it has been set up, select **Edit Sync Settings** on the Media Sync screen.

### Simple Sync

Click **Simple Sync** to automatically synchronize your computer's media folders (My Documents, Personal) with an external drive. Click **OK** on the confirmation screen to

complete the sync task. If you want to make changes to the plan after it has been set up, select **Edit Sync Settings** on the Media Sync screen.

### Custom Sync

Use **Custom Sync** to manually select the folders and media types to synchronize between your computer and an external drive.

1. In the Media Sync window, click **Custom Sync**.

The folder section window opens.

2. Select the folders on your computer to be synchronized with the external drive.
3. Click **Next** to go to the File Types window.
4. To sync only the files that can be opened on specific Apple or Android devices, click the menu below **Sync files for** and then choose the device(s) from the list. Or, keep the menu set to **all digital devices** to sync all files that are identified as movies, music or images with any device. The file types change based on the device you choose.
5. Select one or more of the media type boxes to filter what is synchronized. For example, select Music and Videos and then leave Photos and Documents unchecked if you want to sync only your video and music files.
6. Click **Next**.

The **Media Sync Rules** window opens.

7. Set your sync rules:
  - Sync automatically each time a file changesOr
  - Sync manually using the **Sync Now** button
8. Click **Finish**.

Return to the Seagate Media Sync window if you want to make changes to the plan after it has been set up.

## Managing Your Connected Drives

The **My Drives** window provides a central point from which to manage your connected drives. You can get to the My Drives window by clicking the **My Drives** icon in the menu bar from any other window within the application.

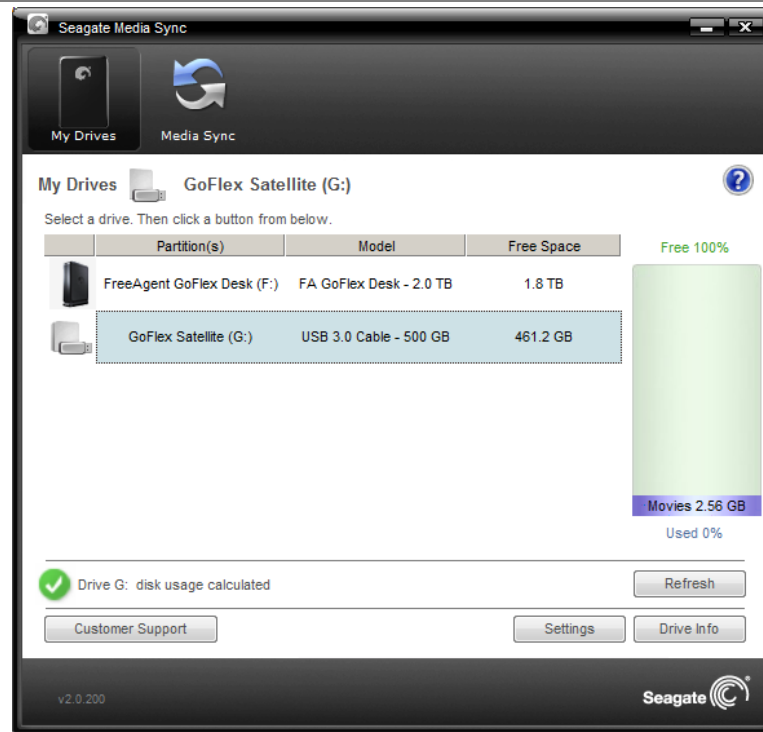

**Figure 11:** Seagate Media Sync

In the **My Drives** window, you first select your drive and then the feature you want to use with it. The middle of the My Drives window displays the connected drives. The currently selected drive is highlighted in light blue. You can use the *Seagate Media Sync* application with any NTFS- or FAT32-formatted USB, FireWire, or eSATA drive.

The icons in the menu bar allow you to move between the My Drives window, used to manage the features of the selected drive, and the **Media Sync** window, used to sync media files on the selected drive with media files on your computer.

- To select a different drive, click the drive icon or partition name.
- To access advanced settings for the selected drive, click **Settings**.
- To get more information about the selected drive, click **Drive Info**.
- To get help, click the help icon. If you're not able to find the answer to your question, click **Customer Support** to go to Seagate's Support Web site.



---

**Note:** All NTFS- and FAT32-formatted USB external drives are automatically detected and listed in the My Drives window. It can take a few seconds for the software to detect your drive. If your drive doesn't appear, make sure it's properly connected and turned on.

---

## Viewing Device Information

1. In the Drives panel, select the drive you want information about and then click **Drive Info**.
  - **Serial number:** The serial number of your drive.
  - **Firmware:** The version of firmware used by your drive.
  - **Volume:** The name of your drive.
  - **Capacity:** The total capacity of your drive.
  - **Free Space:** The amount of space remaining on your drive.
  - **File System:** The Windows file system of your drive.
2. Click **Close** to close the Drive Information window.

## Changing the Seagate Advisor Setting

You can choose whether to show Seagate Advisor popup messages (special promotions and Tips and Tricks) in your system tray.

1. In the Drives panel, select the drive you want to adjust and then click **Settings**.
2. In the Settings window, click **Change Seagate Advisor Setting**.

The Change Seagate Advisor Setting window opens. Show Seagate Advisor messages is selected by default.
3. To turn off Seagate Advisor pop-up messages in your system tray, deselect **Show Seagate Advisor messages**.

---

**Note:** Turning off Seagate Advisor system tray popup messages does not turn off Software Update Notification popup messages.

---

## 4. Managing Your GoFlex Satellite™ Device

Once your *GoFlex Satellite*™ device has been set up, you may want to adjust its settings, upgrade its software (when available), create a password and more.

Here's a list of what's in this chapter. Click a link to jump to the information:

- ["Resetting Your GoFlex Satellite Device"](#)
- ["Restarting Your GoFlex Satellite Device"](#)
- ["Shutting Down the GoFlex Satellite Device"](#)
- ["Restoring GoFlex Satellite to its Original Settings"](#)
- ["Updating GoFlex Satellite Software"](#)
- ["Disconnecting From the GoFlex Satellite Network"](#)
- ["Changing the Name of Your GoFlex Satellite Device"](#)
- ["Disconnecting From the GoFlex Satellite Network"](#)
- ["Deleting Content from Your GoFlex Satellite Device"](#)

### Resetting Your GoFlex Satellite Device

If your *GoFlex Satellite* device isn't working as you expect it to, try resetting the device by pressing and holding the Power button for 15 seconds. This turns off the LEDs, and then shuts down and restarts the device.

### Restarting Your GoFlex Satellite Device

If you experience minor problems with your *GoFlex Satellite* device, follow these steps to restart the device.

---

**Note:** Restarting your *GoFlex Satellite* device does not remove any user settings or delete content from the device.

---

#### To shut down and restart your *GoFlex Satellite* device

1. Make sure that no one is watching a video, viewing photos, listening to music, or working with any other file stored on the *GoFlex Satellite* device.
2. Open the *GoFlex Media* app or connect to your *GoFlex Satellite* device from a browser.
3. Select **Settings**, and then select **Restart Satellite**.

Your *GoFlex Satellite* device safely shuts down and restarts. When it is fully powered on and broadcasting wirelessly, it appears in the list of wireless networks on your device. You will need to reconnect to your *GoFlex Satellite* device. See “Step 4: Connecting to Your GoFlex Satellite Network” on page 7.

## Shutting Down the GoFlex Satellite Device

Turning off the *GoFlex Satellite* device can be completed in one of two ways: by pressing the Power button or from the GoFlex Media Settings screen. When you turn off your *GoFlex Satellite* device, it stops broadcasting wirelessly.

**To shut down the *GoFlex Satellite* device from the app or browser**

1. From the *GoFlex Media* app or if you are using a browser, select **Settings**.
2. Select **Shut Down Satellite**.

## Restoring GoFlex Satellite to its Original Settings

Restoring the *GoFlex Satellite* device returns it to its original factory defaults. All the files stored on your *GoFlex Satellite* device are retained—no files or folders are deleted—but all other settings, such as the your *GoFlex Satellite* device name and password, are removed. You may need to perform this task in the event that you forget your password. Pressing the factory default button on the bottom of the *GoFlex Satellite* device performs the same function.

**To restore your *GoFlex Satellite* device**

1. Make sure that no one is watching a video, viewing photos, listening to music, or working with any other file stored on your *GoFlex Satellite* device.
2. From the *GoFlex Media* app or if you are using a browser, select **Settings**.
3. Select **Restore All Settings**.

Or

4. Using a paperclip, press and release the factory defaults button. The factory defaults button is located on the bottom of the *GoFlex Satellite* device.

The *GoFlex Satellite* device name is changed back to “GoFlex Satellite” and any password you may have set is erased. See “Changing the Name of Your GoFlex Satellite Device” on page 28 or “Setting a Password” on page 28 to reset these preferences.

You will need to reconnect to *GoFlex Satellite*. See “Step 4: Connecting to Your GoFlex Satellite Network” on page 7.

## Updating GoFlex Satellite Software

From time to time, new software is available for your *GoFlex Satellite* device. To check if new software is available, go to [www.seagate.com/support/goflexsatellite](http://www.seagate.com/support/goflexsatellite). If new software is ready, it will be available from this site.

Once you download the software, follow these steps to update the *GoFlex Satellite* software.

1. From the *GoFlex Media* app or if you are using a browser, select **Settings**.
2. Select **Update Satellite Software**.
3. Follow the instructions on the screen to update the software.

## Changing the Name of Your GoFlex Satellite Device

The *GoFlex Satellite* device is named “GoFlex Satellite” by default. This is the network name that appears in the wireless network list when you choose to connect to the *GoFlex Satellite* device from your Wi-Fi device. This name is also known as the SSID (Service Set Identifier).

You can change this name if you prefer it to be named differently. Follow these steps to change the GoFlex Satellite name:

1. From the *GoFlex Media* app or if you are using a browser, select **Settings**.
2. Select **Change Satellite Name**.
3. Type a new name and then click **Next**.
4. Type the name one more time to confirm the name change.

You will need to reconnect to your *GoFlex Satellite* device after the name has been changed.

## Disconnecting From the GoFlex Satellite Network

**To disconnect from the *GoFlex Satellite* network**

1. Open your media device’s list of wireless networks.
2. Choose a wireless network other than GoFlex Satellite.

## Setting a Password

Create a password if you want to restrict access to your *GoFlex Satellite* device. You may want to set a password if you’re in an environment where you don’t want others to connect to your *GoFlex Satellite* device. Setting a password turns WPA security on, which protects your wireless transmissions with your *GoFlex Satellite* device. To stop requiring a password after one has been created, select Turn Password Off and then enter the current password.

1. From the *GoFlex Media* app or if you are using a browser, select **Settings**.
2. Select **Turn Password On**.

3. Type your password and then click **Next**.

The password must be at least eight characters long and no more than 64 characters. All ASCII characters are acceptable. Most of these characters are available on your device's keyboard.

4. Type the password one more time to confirm the change.

## Changing the Language of the *GoFlex Media*™ app

The GoFlex Media app supports 12 different languages. You can change the language of the app from the Settings screen.

---

**Note:** This only changes the language of the *GoFlex Media* app; it has no effect on the language of the media device you are using.

---

1. From the *GoFlex Media* app or if you are using a browser, select **Settings**.
2. Select **Language** from the bottom of the screen and then choose the language you want.

## Disconnecting Your GoFlex Satellite Device From Your Computer

To avoid losing data or damaging your files, follow these instructions to safely remove your *GoFlex Satellite* device from your computer:

1. Make sure that no files on *GoFlex Satellite* are open or in the process of being saved or copied to the device.
2. Depending on the operating system you are using, safely eject the drive from your computer:
  - For Mac OS, drag the *GoFlex Satellite* device icon from the desktop to the trash.
  - For Windows, click the **Safely Remove Hardware** icon. Windows operating systems list the drive as a USB Mass Storage Device.
3. Wait for the lights on the USB 3.0 adapter to turn off.
4. Once the lights turn off, you can safely remove your *GoFlex Satellite* device from your computer.

## Deleting Content from Your GoFlex Satellite Device

To delete content from your *GoFlex Satellite* device, connect your device to your computer using the USB 3.0 adapter and cable. Browse the driver's folders, and then delete files.

## 5. An Overview of Your GoFlex Satellite Device

This chapter provides an overview of your *GoFlex Satellite* device (powering on the device, charging, understanding the LED lights, etc.).

### Understanding the Components of Your *GoFlex Satellite* Device

This section identifies the the different parts that make up your *GoFlex Satellite* device and provides information to help you keep your device charged and ready to stream your media library to your viewing/listening device.

The following diagram shows an illustration of your *GoFlex Satellite* device.

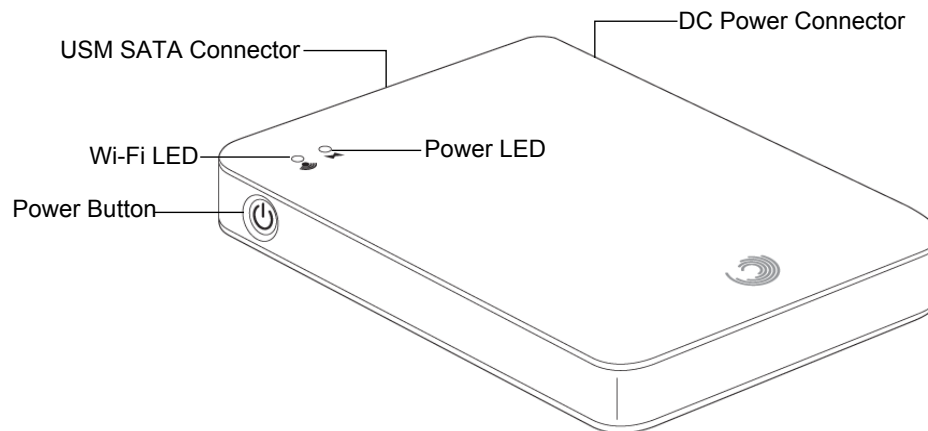
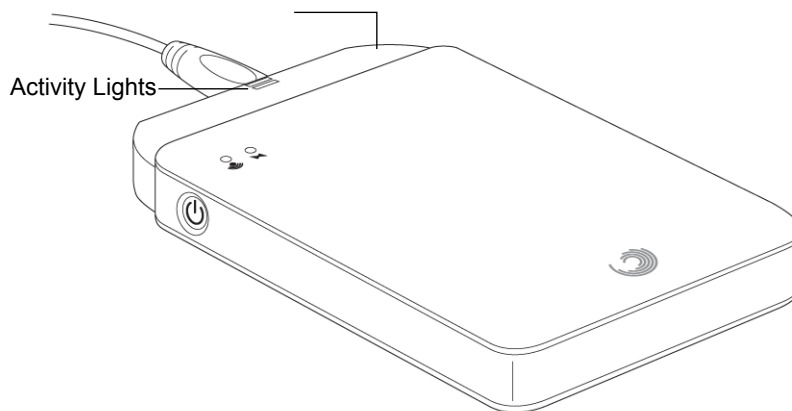

**Figure 3:** GoFlex Satellite Device

- **Power button:** Press to turn on the *GoFlex Satellite* device. Press again to turn off.
- **Wi-Fi LED:** Indicates the *GoFlex Satellite* device's wireless broadcasting state.
  - Green blink: *GoFlex Satellite* device is starting up.
  - Green solid: *GoFlex Satellite* device is Wi-Fi ready.
  - Blue blink: *GoFlex Satellite* device is broadcasting.
- **Power LED:**
  - Green solid: Fully charged.
  - Amber: Charging.

- Red: Battery is low; requires a charge. See “Charging the Battery” on page 26.
- **USM™ (Universal Storage Module) SATA Connector:** Connects your *GoFlex Satellite* device to the supplied USB 3.0 adapter/cable and to your computer.
- **DC Power Connector:** Connects your *GoFlex Satellite* device to the USB to the DC power cable.
- **Factory Defaults button:** (This button is located on the bottom of your *GoFlex Satellite* device.) Press and release this button to reset your *GoFlex Satellite* device to its original factory settings. No data is lost during this process.  
For more information, see “Restoring GoFlex Satellite to its Original Settings” on page 27.

The following diagram shows the USM SATA connector and USB cable connected to the GoFlex Satellite device.



**Figure 4:** USB 3.0 Adapter Activity Lights

The USB 3.0 adapter activity lights illuminate when your *GoFlex Satellite* device is connected to your computer with the detachable USB 3.0 cable.

**Note:** When you connect your *GoFlex Satellite* device to your computer, wireless is automatically disabled.

- **Adapter cable activity lights:**
  - **White steady:** Your *GoFlex Satellite* drive is connected to your computer and ready for use.
  - **White blink:** Activity.
  - **No lights:** Your *GoFlex Satellite* drive is safe to remove from your computer, is not connected or the lights have been disabled using the application.

## Charging the Battery

The *GoFlex Satellite* device uses a rechargeable lithium-ion battery. A fully charged battery provides up to five hours of continuous streaming. However, the battery will lose its charge faster when playing higher resolution video. When the device is in standby mode, the battery retains its charge for up to 25 hours. Your *GoFlex Satellite* device enters standby mode after five minutes of inactivity.

---

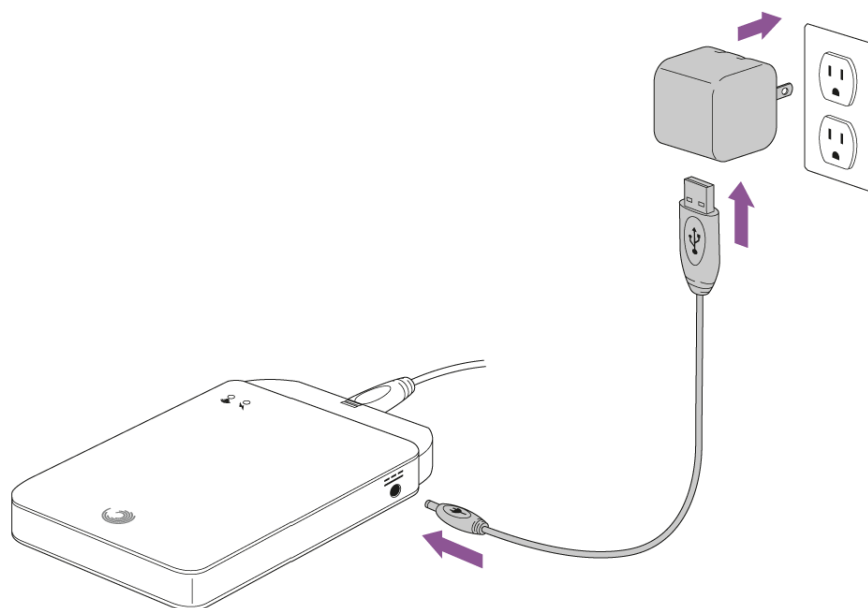

**Figure 5:** Charging GoFlex Satellite

When the power LED turns red, your *GoFlex Satellite* device has about 15-20 minutes of battery life and should be charged soon. The fastest way to charge the battery is to connect the *GoFlex Satellite* device to a power outlet using the included USB to DC power cable and the USB wall adapter. If you're travelling, you can also use the USB to DC power cable together with the USB car charger. It takes about four hours to charge the battery.

---

**Note:** For safety purposes, the drive stops charging after four hours.

---

Your *GoFlex Satellite* device also charges when it is connected to a computer, but at a slower rate.

The lithium-ion battery inside your *GoFlex Satellite* device is not user-replaceable. The lifespan of rechargeable batteries can be affected by the number of charge cycles. See [www.seagate.com/support/goflexsatellite](http://www.seagate.com/support/goflexsatellite) for information about recycling and proper disposal.



## 6. Troubleshooting

The *GoFlex Satellite*™ device is a plug and play device. However, in certain situations, the setup process and product usage may require extra attention. Below is a list of troubleshooting tips to assist you should you have any problems during setup.

### Common Problems and Solutions

This section provides suggestions for solving common problems.

#### It takes awhile for my files to appear in the GoFlex Media app or Web browser

The *GoFlex Satellite* device performs a one-time scan of any content you copy to the drive. This scanning process may take a little time if you copy a large amount of data.

If you recently copied content to the *GoFlex Satellite* drive and you don't see your files: "Pull up" the screen or click **Check for latest content** to refresh the files within the *GoFlex Media*™ app, or click the refresh button to update the page you are viewing from a browser.

#### Can't connect wirelessly to the GoFlex Satellite Device

- Make sure the *GoFlex Satellite* device is disconnected from your computer, powered on and that the Wi-Fi LED is a steady green or blinking blue. Steady green indicates the device is ready to be connected; blinking blue indicates the device is broadcasting.

**Tip:** The *GoFlex Satellite* device does not broadcast while connected to a computer.

- Make sure to select **GoFlex Satellite** from your device's wireless network list. If you leave the *GoFlex Satellite* device's wireless range, your device will disconnect from the GoFlex Satellite wireless signal. The wireless range is close to 150 feet. Any obstructions, such as walls between your device and *GoFlex Satellite*, may affect the strength of the signal. You will have to rejoin the network in this case.
- If you know that the *GoFlex Satellite* device is broadcasting, but you can't connect to it, there may be too many devices connected to *GoFlex Satellite*. You can connect three or more devices to your *GoFlex Satellite* device at one time.
- Make sure the *GoFlex Satellite* device is powered on. If *GoFlex Satellite* is powered off, it stops broadcasting and the wireless connection from your device is lost. To reconnect, select "GoFlex Satellite" from your device's wireless network list.
- If you are attempting to stream using a browser, make sure that your device's wireless connection is enabled. Go to any URL to be redirected to the GoFlex Satellite main page. You can also type [www.goflexsatellite.com](http://www.goflexsatellite.com) in the browser's address bar to connect to your *GoFlex Satellite* network.
- Click the Refresh button on your browser.

### **A song, video or other file won't play**

- Make sure that your device supports the file format.

You can copy any file to the *GoFlex Satellite* drive, however, the device to which you stream your media files will only play or view the formats it supports. Your *GoFlex Satellite* device does not transcode (convert) the files you copy to the drive. See your device's specifications for a complete list of supported file types.

If you want to convert video files to different formats so they can be played on your device, you'll need to transcode the files before copying them to the drive.

### **I just copied a video file purchased from iTunes® to the GoFlex Satellite device but it won't play**

Videos purchased from iTunes are DRM (Digital Rights Management) protected. To play these videos, you must sync your iPad/iPhone/iPod touch with your iTunes account for the new files to play from your *GoFlex Satellite* device.

When you choose to play an iTunes purchased video in the *GoFlex Media* app it will be played from the Safari browser.

### **I mistakenly reformatted the drive for my Mac**

- The *GoFlex Satellite* device is designed to work with both Windows and Mac operating systems. However, you must install the Seagate GoFlex software (MacInstaller.dmg) to enable file copying from a Mac. If you reformatted the drive by mistake, first return the drive to its original NTFS format and then download the Seagate GoFlex software from [www.seagate.com/support/goflexsatellite](http://www.seagate.com/support/goflexsatellite).
- If you are using Time Machine®, do not allow the program to use the *GoFlex Satellite* drive for backup. Time Machine will attempt to reformat the *GoFlex Satellite* drive.

### **I can't connect to GoFlex Satellite from my smartphone**

Make sure you have selected "GoFlex Satellite" from your wireless network list. For more information, see "Connecting to the GoFlex Satellite Network from a Smartphone" on page 9.

### **My computer won't connect to GoFlex Satellite**

Make sure to enable your wireless settings and select "GoFlex Satellite" from your wireless network list. For more information, see "Connecting to the GoFlex Satellite Network from a Computer or Browser" on page 9.

### **The GoFlex Satellite device seems to shut down by itself**

Your *GoFlex Satellite* device includes a power-save feature, which means that it enters a standby state after 5 minutes of inactivity. Your *GoFlex Satellite* device automatically returns to active mode whenever someone attempts to access the device.

**I know the GoFlex Satellite device is broadcasting, but I can't connect to it**

Three or more wireless-enabled devices can stream from the *GoFlex Satellite* device at one time. To see how many devices are currently connected to the *GoFlex Satellite* device, open the GoFlex media app and tap the Connected icon.

**The GoFlex Satellite device beeps when I plug it in to my computer**

Your *GoFlex Satellite* device is low on battery power. Connect your *GoFlex Satellite* device to a power outlet using the included USB to DC power cable and the USB wall adapter to charge the device.

**Album cover art appears in my photo slideshows**

Your *GoFlex Satellite* device includes pictures that are larger than 50 kilobytes in its collection of photos, so album cover art larger than this will appear in photo slideshows. To prevent album cover art from appearing in slideshows, make sure that album cover art is smaller than 50 kilobytes.

## Finding More Help

If you haven't found answers to your questions, go to [www.seagate.com/support/goflexsatellite](http://www.seagate.com/support/goflexsatellite) and review:

- How-to videos
- Firmware updates (when available)
- Software updates (when available)
- FAQs

In addition to the information provided in this guide, you can view a video located on your *GoFlex Satellite* device for an overview of setting up and using your new *GoFlex Satellite* device. To view the video, connect the *GoFlex Satellite* device to your computer and locate the video titled "Getting Started."